

INSTRUCTION MANUAL

CS-315C

**MetalMaster Cold Saw, Includes Stand (240V)
110 x 70mm**



S827

Table of Contents

1 SAFETY REGULATIONS	3	11 MATERIAL CLASSIFICATION AND CHOICE OF TOOL	15
1.1 General Safety Advice.....	3	11.1 Disk Structure.....	15
1.2 Blade Guard Safety	3	11.2 Choosing the Saw Blade.....	15
1.3 Emergencies	3	11.3 Type of Disks	16
2 MACHINE DIMENSIONS.....	3	11.4 Choosing the Tooth Pitch.....	17
3 TECHNICAL CHARACTERISTICS	4	11.5 Cutting and Advance Speed	17
3.1 General Characteristics.....	4	11.6 Running in the Disk.....	18
4 TRANSPORTING THE MACHINE.....	4	11.7 Cutting Speed Chart.....	18
5 GETTING TO KNOW YOUR MACHINE..	4	11.8 Recommended Cutting Parameters	19
5.1 Disk Head Assembly	4	12 EXPLOSION DRAW AND PART LISTS	20
5.2 Machine Base.....	5	12.1 Explosion draw A	20
5.3 Vice	5	12.2 Part List A.....	21
5.4 Support Roller	5	12.3 Part List B.....	22
5.5 Stand	5	12.4 Explosion draw B	23
5.6 Coolant Pump.....	5	12.5 WIRING DIAGRAM AND PARTS LIST.....	24
6 GETTING STARTED	6	13 TROUBLESHOOTING.....	26
6.1 Minimum Requirements for Housing the Machine.....	6	13.1 Blade and cut diagnosis	26
6.2 Anchoring the Machine.....	6		
6.3 Assembly and Setup	6		
7 RECOMMENDATIONS AND ADVICE	9		
7.1 General Advise Before Using the Machine.....	10		
7.2 Operator Position	10		
7.3 Deactivating the Machine	10		
7.4 Dismantling.....	10		
8 ADJUSTING THE MACHINE.....	11		
8.1 Disk Head.....	11		
8.2 Adjusting the Mitering Lock Lever ...	11		
8.3 Changing the Disk.....	11		
8.4 Cleaning and Accessing the Coolant System	11		
9 THE OPERATION CYCLE.....	12		
9.1 Miter Angle	12		
9.2 Vise Operation.....	12		
9.3 Loading the Work-piece	12		
9.4 Setting Cutting Length.....	13		
9.5 Operation Cycle.....	13		
10 ROUTINE AND SPECIAL MAINTENANCE.....	14		
10.1 Daily Maintenance.....	14		
10.2 Weekly Maintenance	14		
10.3 Monthly Maintenance	14		
10.4 Six-Monthly Maintenance	14		
10.5 Oils for Lubricating Coolant.....	14		
10.6 Oil Disposal	14		
10.7 Special Maintenance	14		

1 SAFETY REGULATIONS

This machine complies with the national and local accident prevention regulations. Improper use and/or tampering of the machine will relieve the manufacturer of all responsibility.

1.1 General Safety Advice

- Always wear suitable eye protection.
- Always disconnect the machine from the power source before changing the saw blade/cutting disk, or performing any maintenance work.
- Never expose your hands or limbs to the cutting area while the machine is operating.
- Do not shift the machine while in operation..
- Do not wear, gloves, very loose or long clothing, long and loose sleeves, bracelets, chains, neck ties; or any other object that could get caught in the machine during operation
- Tie back long hair.
- Keep the work area free of equipment, tools or any other object.
- Focus on one task at a time
- Keep your hands free; do not carry too many objects in your hands.
- Keep your hands clean.
- When the machine is not in use, the saw blade should not be moving.

1.2 Blade Guard Safety

- The blade guard is a self –adjusting cover that prevents contact with the blade. Never use the machine without the blade guard.
- Never handle blade guard while the blade is running.

1.3 Emergencies

In the event of incorrect operation or dangerous conditions, the machine may be stopped immediately by pressing the emergency stop button. This will shut off the machine and will require resetting of the emergency stop button.

Note: Resetting of machine operation after each emergency stop is achieved by reactivating the specific restart button.

2 MACHINE DIMENSIONS

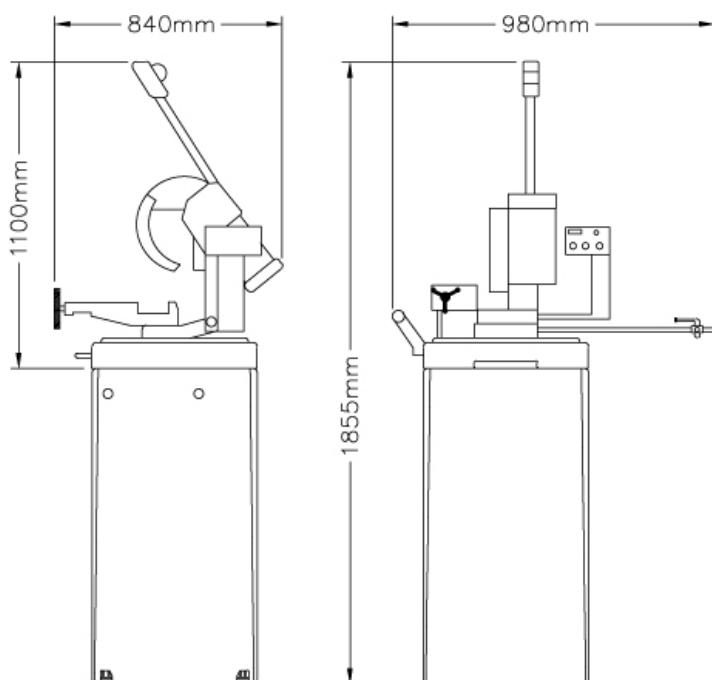

3 TECHNICAL CHARACTERISTICS

3.1 General Characteristics

Cutting Capacity	●	○	□	▭
0°	50mm	100mm	82 x 82mm	110 x 70mm
45°	50mm	90mm	80 x 80mm	85 x 70mm
Main Motor	2HP (1.5kW) / 3ph / 2P / 4P 2HP (1.5kW) / 3ph / 4P / 8P 2.5HP (1.875kW) / 1ph / 4P			
Spindle Speed	2P/ 4P 60HZ - 104 / 52 RPM 50HZ - 88 / 44 RPM 4P/ 8P 60HZ - 52 / 26 RPM 50HZ - 44 / 22 RPM			
Saw Blade	Φ 315 mm			
Maximum Vise Opening	120 mm			
Cooling Pump	1/8 HP			
Coolant tank	5 L			
Machine Weight (with stand)	175 Kgs			
Machine Dimensions (with stand) L x W x H	1020 x 990 x 1830mm			

4 TRANSPORTING THE MACHINE

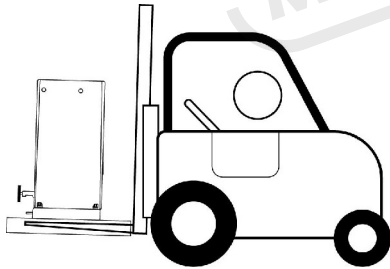

When transporting in its own packaging, use a forklift truck or hand trolley.

5 GETTING TO KNOW YOUR MACHINE

5.1 Disk Head Assembly

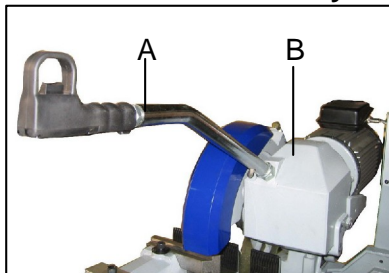

The section of the machine composed motor, gear transfer system, disc or blade, and control handle.

A. Control Lever

A long angled lever with a handle grip and trigger switch for starting, raising, and lowering the disk head

B. Transfer Case

The central part of the assembly, housing the gear system and oil tank.

5.2 Machine Base

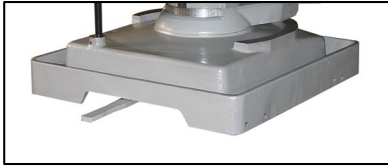

A heavy cast iron structure that supports the miter system, vise system, and head assembly.

5.3 Vice



A clamping system that provides the basic support and security for the work material. Operations are conducted by hand-wheel, which opens and closes the vise jaws.

5.4 Support Roller

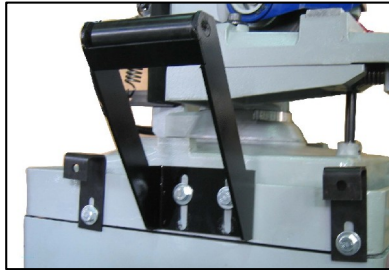

A Device that support longer sized material. The roller assists stock moving through the vise.

5.5 Stand



Support structure for the Machine Head Assembly, Machine Base, and Vise system. The stand also stores the coolant pump.

5.6 Coolant Pump



Found within the machine stand, the coolant pump is a self contained system that includes a tank, pump motor, filters and hoses.

6 GETTING STARTED

- Make sure that the electrical supply and the machine's voltage are the same. Refer to the identification plate on the motor for the correct voltage.
- Use a good quality grounded electrical system.
- All internal and/or internal operations, maintenance or repairs, must be performed in a well-lit area or where there is sufficient light from extra sources so as to avoid the risk of even slight accidents.

6.1 Minimum Requirements for Housing the Machine

The Main voltage and frequency complying with the requirements for the machine's motor.
 Environment temperature from -10°C to +50°C.
 Relative humidity not over 90%.

6.2 Anchoring the Machine

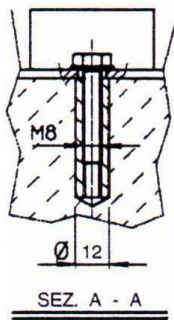

- Position the machine on a firm and level concrete floor.
- Maintain a minimum distance of 800mm from the wall to rear of the machine.
- Anchor the machine to the ground, as shown in the diagram, using screws and expansion plugs or sunken tie rods that connect through holes in the base of the stand.
- Ensuring that it is sitting level.

6.3 Assembly and Setup

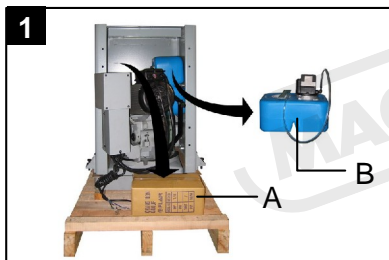

Take out the accessories (A) and the coolant tank (B) from inside of the stand and set aside for later use.

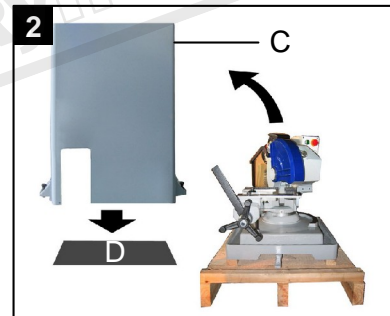

Lift off the stand (C) and place into the intended working location (D).

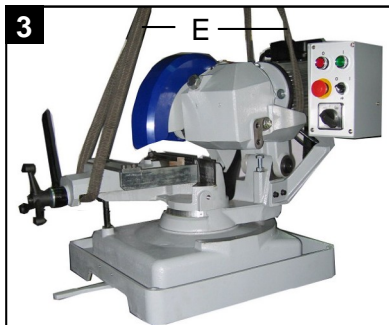

Prepare the machine unit for hoisting

Method one: Use a sling. Carefully wrap the sling (E) around the collar of the movable jaw and motor mount

Method two: Using lift rings. Attach lifting rings to three points on the base of the machine. Attach a three-point sling with grab or sling hooks to the lift rings (F).

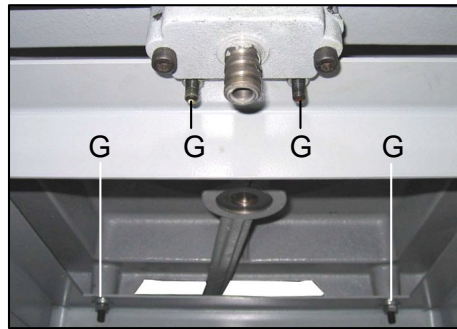
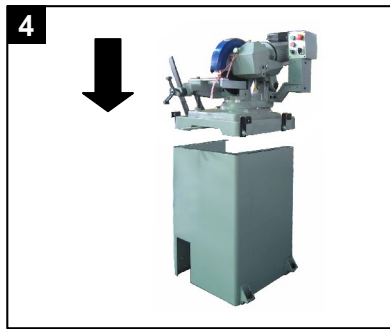

Place the machine on the top of the stand.

- Use an overhead hoist lift the machine unit
- Align the four setscrews (G) on the underside of the machine base to their corresponding holes in the stand.
- Direct the setscrews (G) into their matching holes while lowering the machine onto the stand.
- Secure the machine onto the stand using three nuts to the exposed setscrews on the underside of the stand holes.

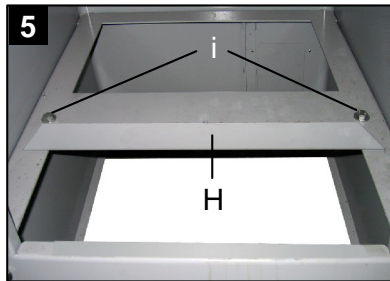

Attach the coolant tank platform.

- Insert platform (H) to the interior of the machine stand.
- Align the platform holes (i) to the screw holes (i) on the interior of the machine stand.
- Apply an M8x18x2, washer to each of 2, M8x12, screws.
- Secure the platform (H) to the stand.

Remove the oil fill transport plug from gear transfer case.

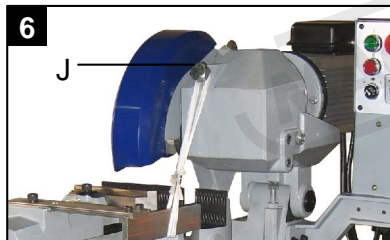

- Use a wrench to unscrew a M20 X 40 hex head screw (J) from the oil fill hole (J).

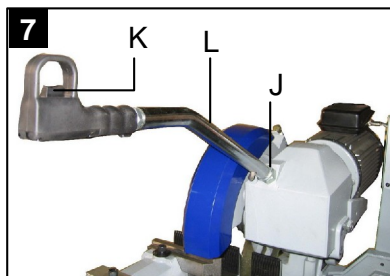

Attach the control handle to the head assembly.

- Insert the threaded end of the control handle into the gear oil fill hole (J).
- Turn the control handle (L) along the shaft to screw in the control handle (L) until a tight fit.
- Align the handle (L) so that the trigger switch (K) point up. (Refer to image)

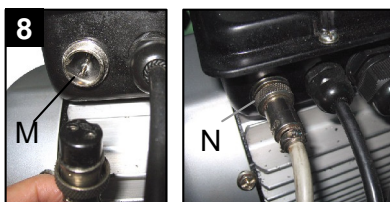

Connect the electric wire with the motor.

- Locate the open socket (M) at the side of the electrical box on the top of the motor.
- Plug in the control handle cable into the open socket (M).
- Use a wrench to screw in the cable connector nut (N).

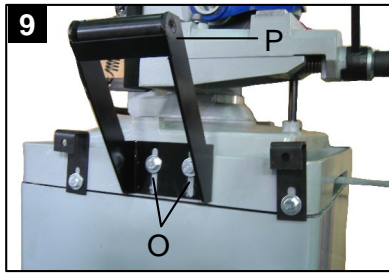

Attach the support roller to the left side of the base.

- Place the support roller (P) up next to the machine base.
- Align the 2 slots (O) in the base of the support roller with the matching screw holes on the base of the machine.
- Apply an M10 washer for each of 2 M10x25 hex head bolts.
- Loosely screw the hex head bolts into the aligned slot (O) and holes.
- Adjust the height of the support roller (P). Place a level across the mouth of the vise and support roller. If a long level is not available, use a straight bar or piece of material then place a small level on top. Raise or lower the support roller until level.
- Secure the support roller (P) into place. Use a wrench to tighten down the 2 hex head bolts.



Attach the bar stop to the vise.

- Insert the thread end of the long rod (R) into the side of the vise.
- Turn the long rod clockwise until snug.
- Use a wrench to turn the M12 hex nut (Q) on the long rod (R) counter-clockwise, so that bar stop unit is secure.

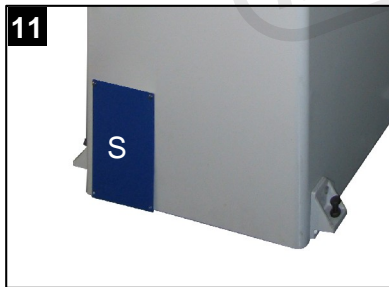

Attach the cover plate to machine stand.

- Place plate (S) next to the hole at the base of the machine stand.
- Align the plate (S) holes the stand holes.
- Use 4, M5X6 screws to secure into place.

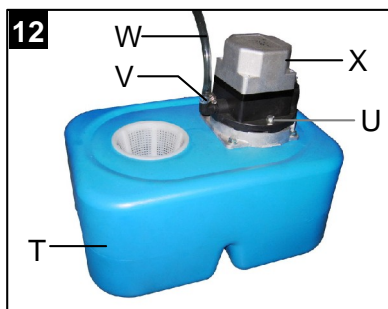

Assemble the coolant tank

- Insert the coolant pump (X) into the coolant tank (T).
- Apply an M6 washer to each of 2 M6x20 screws (U).
- Secure pump (X) to tank (T) with prepared screws (U).
- Place the hose clamp (V) onto the 0.375" flow tube (W).
- Connect the flow tube (W) to the hose connector (V).
- Use a flat head screwdriver to tighten the hose clamp (V).

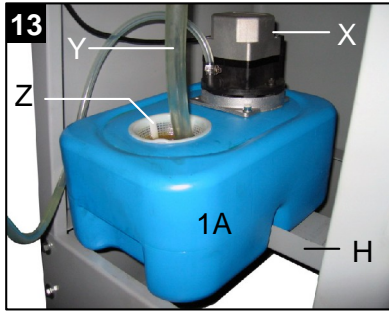

Install the coolant tank

- Orient the coolant pump (X) towards the rear opening of machine stand.
- Place the coolant tank (1A) onto the coolant platform (H). The coolant tank (1A) contains a divider that forms a trough in the bottom of the tank. This trough fit over the vertical lip of the coolant platform (H).
- Insert one end of the 0.5" drain hose (Y) onto the hose connector (1B) on the underside of the machine base.
- Place the other end into the insert (Z) of the coolant tank (1A).

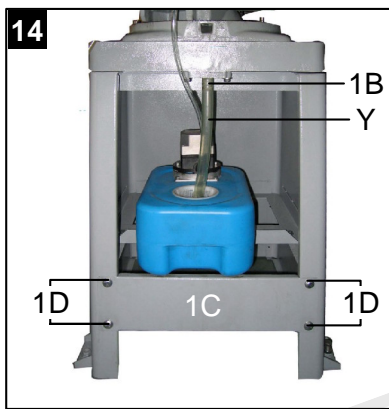

Attach the rear plate to the back of the stand.

- Place rear plate (1C) across the back of the machine stand.
- Align the plate holes (1D) with the set of 4 holes towards the top of the machine stand.
- Apply an M8 washer to each of 4 M8x25 screws.
- Secure with 4 screws and washers.

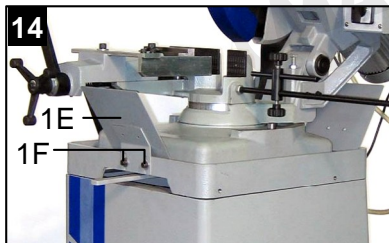

Install the splash plates

- Insert a splash plate (1E) onto the front sidewall of machine base.
- Align the 2 slots (1F) in the base of the splash plate with the matching screw holes on the machine base.
- Apply a washer for each of 2 hex socket head screws M8x20.
- Loosely screw the socket hex head screws into the aligned slot (1F) and holes.
- Adjust the splash plate (1E) to the proper position and tighten down the screws to secure.
- Insert a longer one of splash plate (1G) onto the rear sidewall of the machine base. This plate need not be secured with screws to allow free movement or convenient removal.

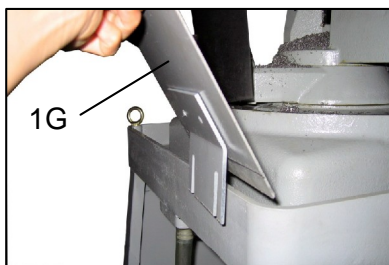

7 RECOMMENDATIONS AND ADVICE

7.1 General Advise Before Using the Machine

- This machine is designed to cut metal construction materials of different shapes and profiles. The materials may be required for fabrication workshops, machinist shops, and general construction work.
- Limit the machines use to a single operator.
- To obtain good running-in of the machine it is advisable to start using it at intervals of about half an hour. This operation should be repeated two or three times, after which the machine may be used continuously.
- Always check that the workpiece is securely clamped and that long pieces are suitably supported.
- Do not use a disk size that is outside the limits of the machine specifications.
- Immediately release the start/run/trigger button if the disk should get stuck in a cut. Switch off the machine before raising the machine head. Then open the vise and remove the workpiece. Lastly, check the disk teeth for any damage. If any of the teeth are broken, replace the saw blade.
- Before carrying out any repairs of the machine, consult a technician.

7.2 Operator Position

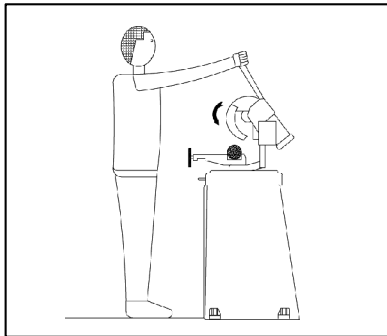

The operator should stand in front of the machine using a single hand to grip the control handle.

7.3 Deactivating the Machine

If the machine is to be inactive for a long period, prepare the machine as follows:

- Detach the plug from the electric supply panel
- Release the head return spring
- Empty the coolant tank
- Carefully clean and grease the machine
- If necessary, cover the machine.

7.4 Dismantling

General rules

Before disposing of the machine, the machine should be broken down and separated into the 3 categories as follows:

- Cast iron or ferrous materials: These materials should be of single composition, without combination or attachment to other types of materials. This is a recyclable material. The materials may be sent to metal scrap and recycling centers.
- Electrical components: This includes cables and electronic parts (magnetic cards, etc.). These materials may be considered as urban waste. Give the materials to your local public waste disposal service.
- Old mineral, synthetic and/or mixed oils: Blend oils and greases are special refuse. Have these collected by a service specializing in oil disposal.

Note: Standards and legislation for waste disposal is in a state continuous change and evolution. The user must be informed of current regulation for waste disposal of machine

tools, as they may differ from those described above. They are to be considered as general guideline.

8 ADJUSTING THE MACHINE

BEFORE PERFORMING THE FOLLOWING OPERATIONS, THE ELECTRIC POWER SUPPLY AND THE POWER CABLE MUST BE COMPLETELY DISCONNECTED.

8.1 Disk Head

If excessive axial play is found on the hinge, it will be sufficient to tighten the screws. Pay attention and avoid making the joint too tight.

8.2 Adjusting the Mitering Lock Lever

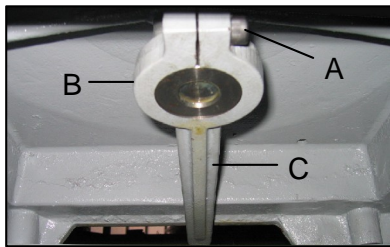

The lock lever may require adjustment when the lever is limited by the machine base and it fail to adequately secure the miter angle for machine head. If there is insufficient brakeage of the lock lever:

- Loosen screw (A)
- Support the bushing (B) so that it does not drop in position.
- Pivot the lever (C) to unlock side to allow more range of motion.
- Then tighten the screw (A).

8.3 Changing the Disk

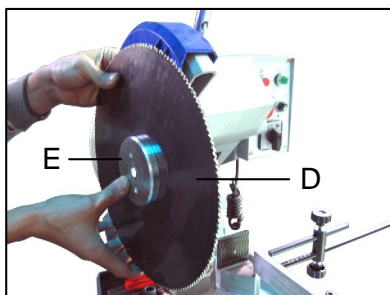
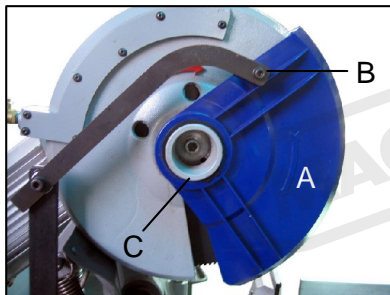

To changed the disk:

- Release the mobile guard (A) by removing the hex socket screw (B).
- Rotate the mobile guard (A) back.
- Place a block of wood into the vise.
- Lower the machine head to rest the cutting disk or saw blade on the block of wood.
- Use a hex wrench to remove the hex socket screw (C),
- Rotate the disk in the clockwise direction to loosen it (because it has a left-handed thread).
- Remove the disk or blade (D) and flange (E) from the head assembly.
- Slip off the flange (E) from the disk (D).
- Place the flange onto the replacement disk or blade (D).
- Continue the replacement of the disk in reverse order of removal of the disk.

8.4 Cleaning and Accessing the Coolant System

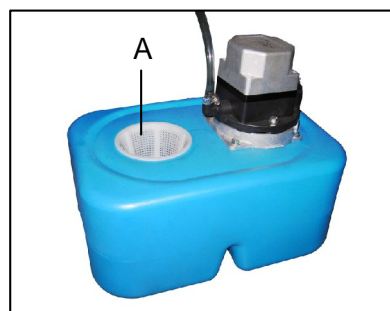

- Pull out the drain hose from the filter (A).
- Pull out the coolant tank from the coolant platform in the stand.
- Remove the filter (A) from the tank
- Pour out the coolant
- Wash out the dirt and debris.
- Replace the filter (A).
- Fill with coolant solution of 1:10 ratio of coolant to water
- Replace the coolant tank in reverse order of removal.

9 THE OPERATION CYCLE

Before operating all the main parts of the machine must be set to optimum conditions (see the chapter on “regulating the machine”)

9.1 Miter Angle

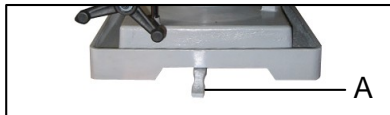
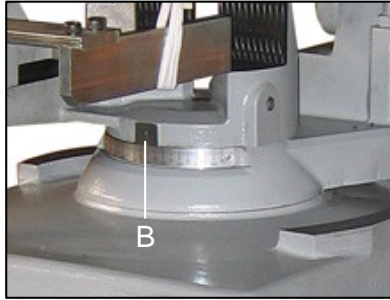

- Use the miter lock lever (A) to release the disk head assembly.
- Rotate the disk head assembly to the correct miter angle.
- Check the miter angle on the angle indicator (B) below the vise
- Use the miter lock lever (A) to lock in the miter angle.

9.2 Vise Operation

The quick clamp vise lever allows the operator to quickly clamp and unclamp work-pieces of same width. This allows for efficient use of machine for loading and feeding forward work-pieces.

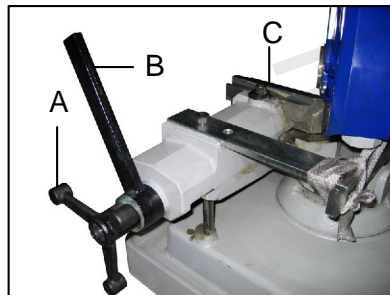

Use the hand wheel to open and close the vise jaw for work pieces that vary in width.

- Rotate the hand-wheel (A) counter-clockwise to open the vise.
- Rotate the hand-wheel (A) clockwise to close and approach the vise jaw (C) to the work pieces.

Use the vise lever to quickly clamp and unclamp work pieces of the same width.

- Rotate the vise lever (B) clockwise to clamp the work-piece.
- Rotate the vise lever (B) counter-clockwise to unclamp the work-piece.

9.3 Loading the Work-piece

- Use the vise hand-wheel to open the vise wider than the width of the work-piece.
- Measure and mark off the length of material desired to be cut-off.
- Place the work-piece on the flat surface in between the vise jaws.
- Slide the work-piece across the vise so that the length mark lines up with the blade or disk.
- Press the work-piece up against the back vise jaw.
- Use the vise hand-wheel to clamp the work-piece.

If repetitive cuts are required for material of the same width:

- Use the vise hand-wheel to approach the work-piece, but leave an approximate 5mm gap between the mobile vise jaw and the work-piece.
- Then use the vise lock lever to clamp and unclamp the work-piece.

9.4 Setting Cutting Length

Setting the cutting length removes the need to repeatedly measure work-pieces for repetitive cuts of a single length.

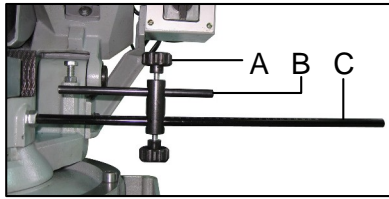

- Measure and mark off the length of material desired to be cut-off.
- Load the work-piece.
- Line up the cut
- Clamp the work-piece.
- Loosen the hex nut at the base of the bar riser (A).
- Slide the bar riser (A) along the long rod (C) so that the tip of stop bar (B) touches the end of the work-piece.
- Tighten the hex nut at the base of the bar riser (A).

The stop bar in use

- Cut off the first length of work-piece.
- Unclamp the work-piece
- Slide the work-piece forward until it reaches tip of the stop bar (A).
- Clamp the work-piece.
- Then proceed with the operation cycle

9.5 Operation Cycle

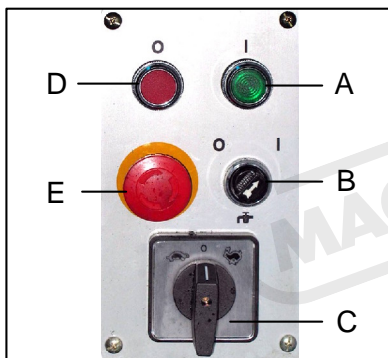

- Set the miter cut angle, if necessary
- Open the vise, if necessary
- Load the work-piece
- Clamp the work-piece
- Adjust the bar stop for cutting length, if necessary
- Check that the main power light is ON (A).
- Set the speed (C).
- Set the coolant switch (B).
- Grasp the control handle (G).
- Press the trigger switch (F) to start.
- Pull down the control handle (G). Apply a steady and constant pressure.

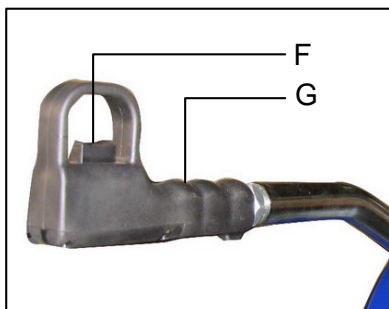

- After cut off
- Raise control handle slowly
- Press the stop button (D)
- Use vise lever to open the vise
- Remove or feed the work-piece forward
- Repeat operation cycle, if necessary

The chopper is now ready to start work, bearing in mind that the CUTTING SPEED and the TYPE of DISC – combined with a suitable descent of the head– are of decisive importance for cutting quality and for machine performance.

When starting to cut with a new disk, in order to safeguard its life and efficiency, the first two or three cuts must be made while exerting a slight pressure on the part, so that the time taken to cut is about double the normal time.

Press the red emergency button (E) when there are conditions of danger or malfunctions in general, so as to stop machine operation immediately.

10 ROUTINE AND SPECIAL MAINTENANCE

THE MAINTENANCE SCHEDULE HAS BEEN DIVIDED INTO DAILY, WEEKLY, MONTHLY, AND SIX-MONTHLY INTERVALS. NEGLECTING THE MACHINE MAINTENANCE WILL RESULT IN PREMATURE WEAR AND POOR PERFORMANCE.

10.1 Daily Maintenance

Make a general cleaning by removing dust and shavings from the machine.
Top off the coolant.
Inspect the disk/saw blade for wear.
Raise the head into a high position to reduce stress on the return spring.
Check that the shields and emergency stops are in good working order.

10.2 Weekly Maintenance

Thoroughly clean the machine including the coolant tank.
Clean and grease the vice screw and sliding surfaces.
Clean the housing for disk/saw blade.
Sharpen the saw teeth.

10.3 Monthly Maintenance

Check that all screws on the motor, the pump, the vise jaws, and the guard are tight and secure.
Check that the guard is free from defect.
Grease the hinge pin for the head assembly.

10.4 Six-Monthly Maintenance

Change the oil in the reduction unit using oil type DN SUPER GEAR 460 by IDEMITSU or DAPHON or equivalent oil, proceeding as follows:

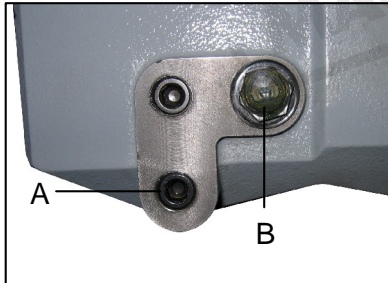

Remove the connecting plug from the electric box and unscrew the control handle.
Drain off the old oil from the drain hole (A)
Pour in new oil up to the mark (B), through the hole for the control handle, keeping head in a horizontal position.
Reassemble all the parts.
Check continuity of the equipotential protection circuit.

10.5 Oils for Lubricating Coolant

Considering the vast range of products on the market, the user can choose the one most suited to his own requirements, using as reference the type SHELL LUTEM OIL ECO. THE MINIMUM PERCENTAGE OF OIL DILUTED IN WATER IS 8~10%.

10.6 Oil Disposal

Oil products must be disposed in a proper manner following local regulations. Please refer to "Machine disposal."

10.7 Special Maintenance

Special maintenance operations must be carried out by skilled personnel. However, we advise contacting dealer and/or importer the term special maintenance also covers the resetting of protection and safety equipment and devices.

11 MATERIAL CLASSIFICATION AND CHOICE OF TOOL

The goal is to produce an excellent quality cut and efficiency during multiple identical cuts. The user must consider the quality of material in respect to hardness, shape, and thickness to determine the proper descent rate, blade/disk speed, and saw blade/disk type. A harmonious combination of material, rate, speed, and type are required to achieve a quality cut. So great care and thought should be made into planning for a single operational cycle then efficiency can be achieved for multiple identical operations. With good knowledge of machine specification and careful consideration and common sense, the user can attain the goal and overcome any problem that may appear from time to time.

11.1 Disk Structure

The most commonly used disks are made of extra high speed steel (HHS/Mo5+Co5) with a treated tooth, which differentiates them from the former on account of the high value of structural resistance, greater resistance to seizing, absence of stress in the mass and a better holding of lubricating coolant during work.

11.2 Choosing the Saw Blade

- Choose a tooth pitch that is suitable for the workpiece. Please refer to "Tooth pitch".
- Thin walled or variable section work pieces such as profiles, pipes, and plates require closed tothing, so that at least 3~6 teeth are in contact with the material while cutting.
- Large solid or transverse sections require widely spaced tothing to allow for greater volume of the shavings and better tooth penetration.
- Soft materials or plastics such as light alloys, mild bronze, Teflon, wood, etc., require widely spaced tothing to avoid clogging.

MACHINERYHOUSE

TYPES OF STEEL						CHARACTERISTICS		
USE	I UNI	D DIN	F AF NOR	GB SB	USA AISI-SAE	Hardness		
						BRINELL HB	ROCKWELL HRB	R=N/mm ²
Construction Steels	Fe360	St37	E24	----	----	116	67	360÷480
	Fe430	St44	E28	43	----	148	80	430÷560
	Fe510	St52	E36	50	----	180	88	510÷660
Carbon Steels	C20	CK20	XC20	060 A 20	1020	198	93	540÷690
	C40	CK40	XC42H1	060 A 40	1040	198	93	700÷840
	C50	CK50	----	----	1050	202	94	760÷900
	C60	CK60	XC55	060 A62	1060	202	94	830÷980
Spring steels	50CrV4	50CrV4	50CV4	735 A 50	6150	207	95	1140÷1330
	60SiCr8	60SiCr7	----	----	9262	224	98	1220÷1400
Alloyed steels for Hardening and tempering and for nitriding	35CrMo4	34CrMo4	35CD4	708 A 37	4135	220	98	780÷930
	39NiCrMo4	36NiCrMo4	39NCD4	----	9840	228	99	880÷1080
	41CrAlMo4	41CrAlMo7	40CADG12	905 M 39	----	232	100	930÷1130
Alloyed case hardening steels	18NiCrMo7	----	20NCD7	En 325	4320	232	100	760÷1030
	20NiCrMo2	21NiCrMo2	20NCD2	805 H 20	4315	224	98	690÷980
Steel for bearings	100Cr6	100Cr 6	100C6	534 A 99	52100	207	95	690÷980
Tool steel	52NiCrMoKU	----	----	----	----	244	102	800÷1030
	56NiCrMoV7	----	----	BS 1	S-1	212	96	710÷980
	C100KU	C100W1	Z200C12	BD2 – BD3	D6-D3	252	103	820÷1060
	X210Cr13KU	X210Cr12	Y60SC7	----	S5	244	102	800÷1030
	58SiMo8KU	----	----	----	----	----	----	----
Stainless steel	X12Cr13	4001	----	----	410	202	94	670÷885
	X5CrNi1810	4301	Z5CN18.09	304 C 12	304	202	94	590÷685
	X8CrNi1910	----	----	----	----	202	94	540÷685
	X8CrNiMo1713	4401	Z6CDN17.12	316 S 16	316	202	94	490÷685
Copper alloys Special brass Bronze	Aluminium copper alloy G-CuAl11Fe4Ni4 UNI 5272					220	98	620÷685
	Special manganese/silicon brass G-CuZn36Si1Pb1 UNI5038					140	77	375÷440
	Phosphor bronze G-CuSn12 UNI7013/2a					120	69	320÷410
Cast iron	Gray pig iron G25					212	96	245
	Spheroidal graphite cast iron GS600					232	100	600
	Malleable cast iron W40-05					222	98	420

11.3 Type of Disks

The disks differ essentially in their constructive characteristics, such as:

Tooth shape

Tooth cutting angle

Tooth shape

The profile of the tothing depends on the size, shape and thickness of the section to be cut, either straight or at an angle.

It may also vary according to the pitch, but not so distinctly as to make this an element for classification.

Fine tothing is to be chosen for cutting small sections with a profiled shape and tubular sections with thin walls (2-5mm depending on the material).

Large tothing is suitable for cutting medium and large solid sections or fairly thick profiled or tubular sections (over 5mm).

“A” tothing:

Normal fine tothing

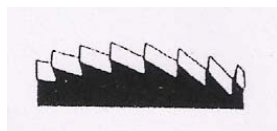

“AW” tothing:

Fine tothing with alternate side rake



“B” toothing:

Normal large toothing with or without shaving breaking inclusion.

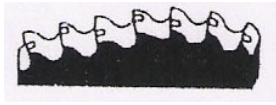

“BW” toothing :

Large toothing with alternating side rake



C(HZ) toothing:

Large toothing with roughing tooth with rake on both sides, alternating with a finishing tooth without rake. The toughing tooth is 0.15-.30 mm higher.



Added toothing:

Disk made in the way are used for cutting non-ferrous metals, such as light alloys, and plastics, and above all in woodworking. The teeth are hard metal (HM) plates brazed onto the body of the disk; there are various types and shapes and, considering the vastness of the field, the topic is not developed further here.

Tooth cutting angle

Each tooth has two cutting angles:

- α : front rake angle
- γ : rear rake angle

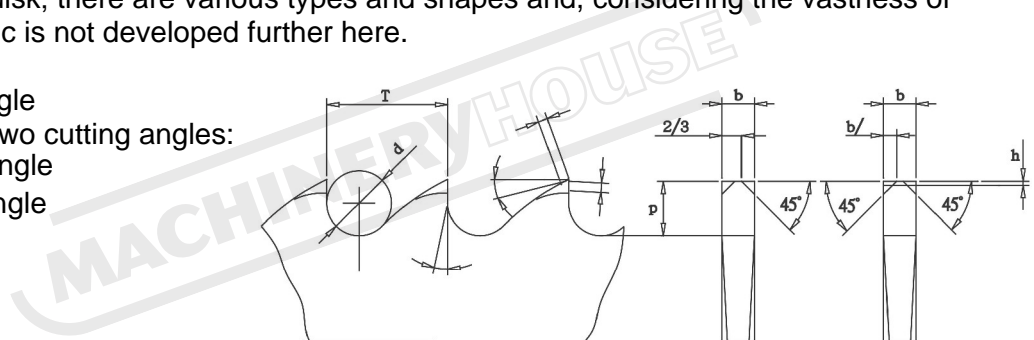

T	3	4	5	6	7	8	9	10	12	14	16
p	1,3	1,6	2,1	2,5	2,9	3,4	3,8	4,2	5,1	5,9	7,2
d	1,5	2	2,5	3	3,5	4	4,5	5	6	7	8
h = 0,2 mm						h = 0,3 mm					

Rakes vary in accordance to material to be cut.

11.4 Choosing the Tooth Pitch

Select tooth pitch based on, harness of the materials, dimensions of the section, and, thickness of the wall

11.5 Cutting and Advance Speed

The cutting speed (m/min) and the advance speed (cm²/min= area traveled by the disk teeth when removing shavings) are limited by the development of heat close to the tips of the teeth.

The cutting speed is subordinate to the resistance of the material ($R = N/mm^2$), to its hardness (HRC) and to the dimensions of the widest section.

To high an advance speed (=disk descent) tends to cause the disk to deviate from the ideal cutting path, producing non-rectilinear cuts on both the vertical and the horizontal plane.

11.6 Running in the Disk

When cutting for the first time, it is good practice to run in the tool making a series of cuts at a low advance speed (=30~35 cm²/min on material of average dimensions with respect to the cutting capacity and solid section of normal steel with R= 410-510 N/mm²), generously spraying the cutting area with lubricating coolant.

11.7 Cutting Speed Chart

Cutting speeds according to disk diameter

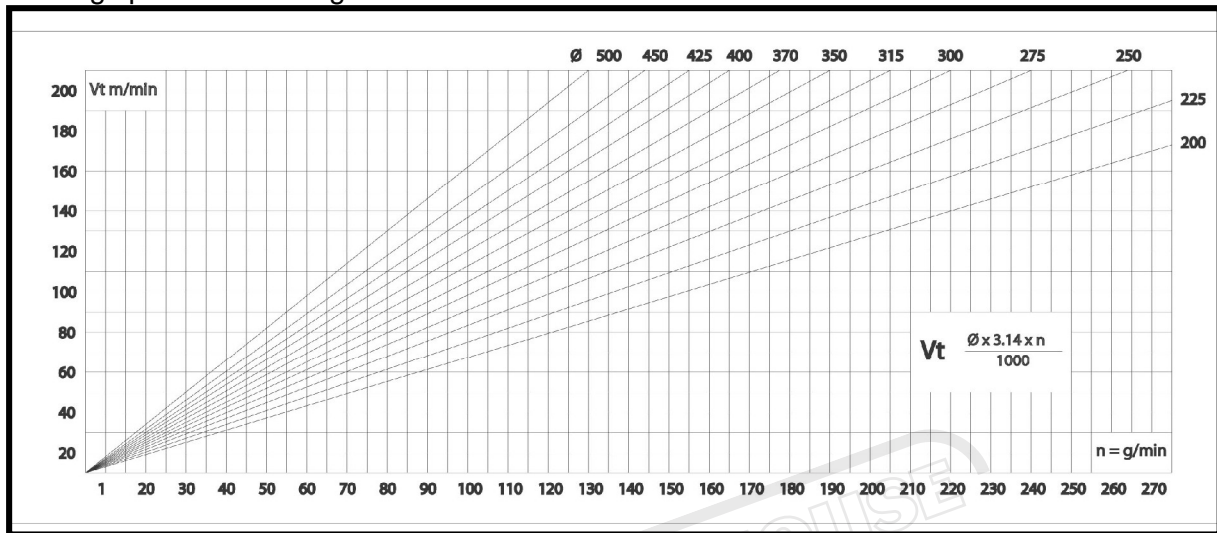

T	Tooth pitch in millimeters	d	Diameter of the tooth fillet cone distance
Av mm/min	Advance in millimeters per minute	h	Tooth protrusion
Vt m/min	Cutting speed in meters per minute	γ	Front rake
Az	Tooth advance	α	Rear rake
Ng/min	Number of revs per minute	N/mm	Ultimate tensile stress
Z	Number of teeth on the disk	a-f	Flat parts of the cutting edge
p	Tooth depth	Φ	Tube diameter of profile width

11.8 Recommended Cutting Parameters

CUTTING ANGLES		Mild steel R=350-500 N/mm ²	Semi-hard steel R=500-700 N/mm ²	Hard steel R=750-950 N/mm ²	Extra-hard steel R=950-1000 N/mm ²	Heat-treated steel R=950-1300 N/mm ²	Austenitic stainless steel R=500-800 N/mm ²	Martensitic stainless steel R=500-800 N/mm ²	Grey cast iron	Aluminium and alloys R=200-400 N/mm ²	Aluminium and alloys R=300-300 N/mm ²	Copper R=200-350 N/mm ²	Phosphor bronze R=400-600 N/mm ²	Hard bronze R=600-900 N/mm ²	Brass R=200-400 N/mm ²	Alloyed brass R=200-400 N/mm ²	Titanium and alloys R=300-800 N/mm ²	Tube and beams 0.05 D R=300-600 N/mm ²	Tubes and beams 0.025 D R=300-600 N/mm ²	
																				γ
SECTION TO BE CUT (IN MM)	10-20	°T mm	5	4	4	3	2	4	4	4	6	5	6	5	4	5	4	3	2	
		Vt m/1'	50	30	20	15	9	20	20	25	1100	200	400	400	120	600	500	50	19	35
		Av mm/1'	160	130	110	60	35	50	50	100	1800	400	600	800	160	1100	700	160	130	130
	20-40	°T mm	7	6	6	4	3	6	6	6	8	7	8	7	8	6	7	4	4	3
		Vt m/1'	45	30	20	15	9	19	19	23	1000	180	350	400	110	600	400	45	18	30
		Av mm/1'	150	120	110	60	33	45	45	100	1700	400	600	700	150	1100	600	150	120	110
	40-60	°T mm	10	9	8	6	4	8	8	8	12	10	11	10	8	10	10	6	5	4
		Vt m/1'	45	25	18	14	9	18	18	22	900	160	300	350	100	550	350	45	18	30
		Av mm/1'	140	110	100	50	30	45	45	90	1600	350	550	700	140	1000	600	140	110	110
	60-90	°T mm	12	12	11	9	6	11	11	11	16	12	14	12	10	12	12	10	6	5
		Vt m/1'	40	25	17	14	8	17	17	20	800	160	250	300	90	550	350	45	17	30
		Av mm/1'	130	110	50	50	28	40	40	80	1400	300	550	600	130	900	500	130	110	110
	90-110	°T mm	14	14	14	12	8	14	14	14	18	14	17	14	12	16	16	12	6	5
		Vt m/1'	40	20	15	13	8	15	15	19	700	140	200	250	70	500	300	40	16	28
		Av mm/1'	110	100	80	45	25	40	40	880	1300	300	500	600	110	900	500	110	100	100
	110-130	°T mm	16	16	16	14	10	16	16	16	20	16	18	16	14	18	18	14	8	6
		Vt m/1'	35	20	14	13	7	14	14	17	600	130	150	200	60	500	300	35	16	26
		Av mm/1'	100	90	70	45	25	35	35	70	1100	250	500	500	100	800	400	100	90	90
	130-150	°T mm	18	16	16	14	12	16	16	16	20	16	20	18	16	18	18	16	10	6
		Vt m/1'	30	15	12	12	7	12	12	16	500	130	120	150	50	450	200	30	15	24
		Av mm/1'	90	80	60	40	22	35	35	60	900	250	400	400	90	800	400	90	80	80
	RECOMMENDED LUBRICANTS		Emulsion – Cutting oil							Dry	Kerosene Dry	Emulsion			Cutting oil			Emulsion		

12 EXPLOSION DRAW AND PART LISTS

12.1 Explosion draw A

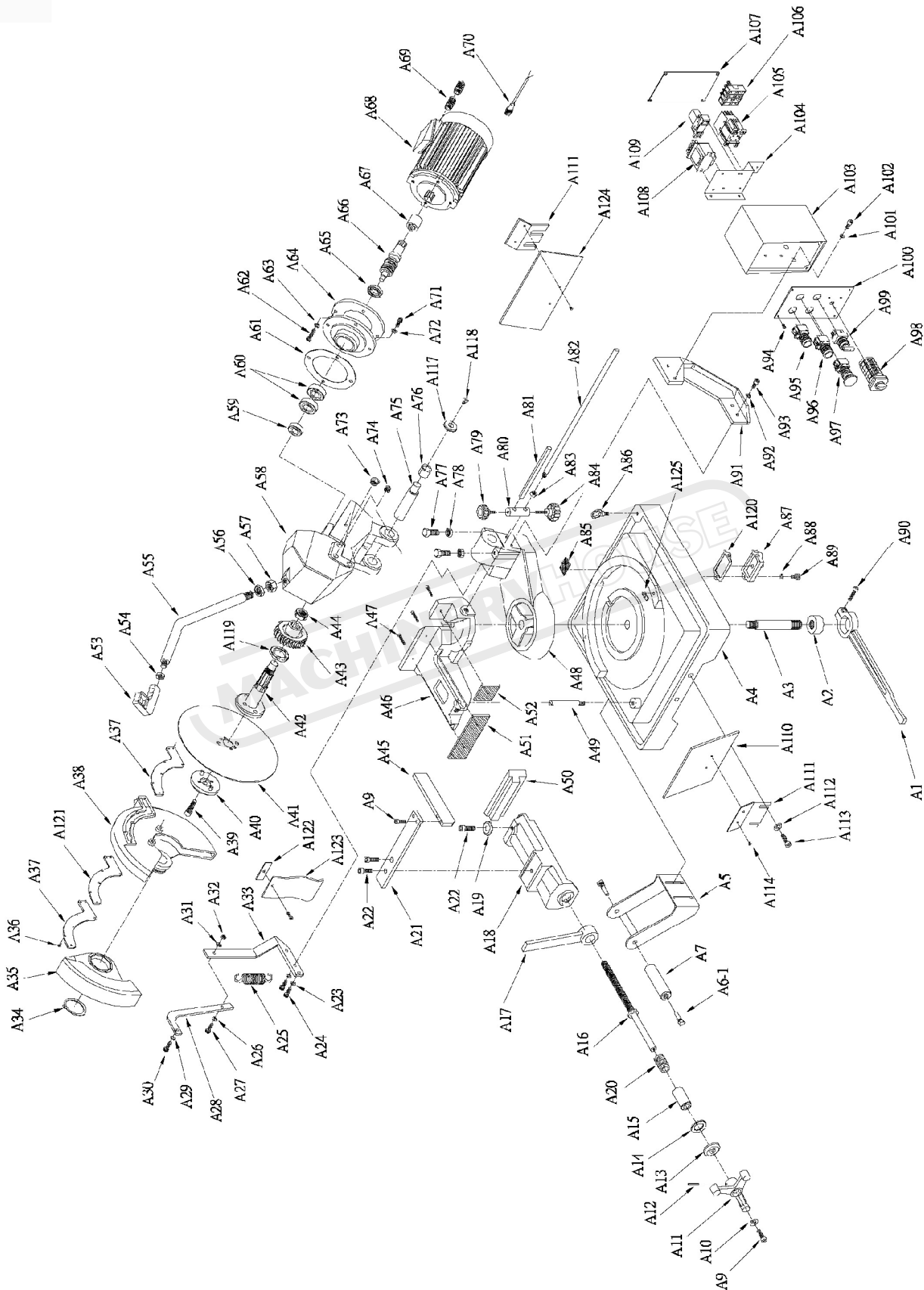

12.2 Part List A

Item	Description	Size	Q'TY
A01	Lock handle		1
A02	Lock Nut		1
A03	Shaft		1
A04	Machine base		1
A05	Roller bracket		1
A6-1	Hex head screw		2
A07	Roller		1
A08	C-clip	S-12	2
A09	Hex socket cap screw	M8x20	1
A10	Washer	5/16"	1
A11	Handle wheel		1
A12	Pin		1
A13	Bearing bushing		1
A14	Bearing		1
A15	Bushing		1
A16	Leading screw		1
A17	Lock handle		1
A18	Sliding vise		1
A19	Washer		1
A20	Spring		1
A21	Plate		1
A22	Hex socket cap screw	M12x25	2
A23	Washer	5/16"	2
A24	Hex socket cap screw	M8x20	2
A25	Spring		1
A26	Washer	5/16"	1
A27	Hex socket cap screw	M8x20	1
A28	Switching handle		1
A29	Washer	1/4"	1
A30	Hex socket cap screw	M6x12	1
A31	Washer	1/4"	1
A32	Nut	M8	1
A33	Switching plate		1
A34	C-clip		
A35	Blade shield		1
A36	Screw	M5x10	7
A37	Plate		
A38	Blade cover		1
A39	Hex socket cap screw	M12x35	1
A40	Fixing flange		1
A41	Saw blade		1

Item.	Description	Size	Q'TY
A42	Spindle shaft		1
A43	Worm gear		1
A44	Lock Nut		1
A45	Stopper		1
A46	Vise bench		1
A47	Hex socket cap screw	M5x25	3
A48	Swing arm (base)		1
A49	Support rod		1
A50	Vise clamp		1
A51	Groove jaw		1
A52	Small groove jaw		1
A53	Trigger switch with handle		1
A54	Nut	M10	1
A55	Control handle rod		1
A56	Nut	M20	1
A57	Nut	M20	1
A58	Machine head		1
A59	Ball bearing	6205zz	1
A60	Ball bearing	6301zz	1
A61	Rubber sheet		1
A62	Hex cap screw	M8x20	4
A63	Washer	5/16"	4
A64	Flange		1
A65	Oil seal		1
A66	Worm shaft		1
A67	Coupling		1
A68	Motor		1
A69	Wire terminal clamp		4
A70	Control wire		1
A71	Hex cap screw	M8x20	4
A72	Washer	5/16"	4
A73	Oil pilot	PT1/2"	1
A74	Set screw	PT1/4"	2
A75	Shaft		1
A76	Bushing		1
A77	Hex cap screw	M12x55	1
A78	Nut	M12	1
A79	Lock bolt with knob		1
A80	Length setting rods bracket		1
A81	Upper length setting rod		1
A82	Lower length setting rod		1

Item	Description	Size	QTY
A83	Nut		1
A84	Lock bolt with knob		1
A85	Filter plate		1
A86	Lift ring		3
A87	Drainage		1
A88	Washer	5/16"	2
A89	Hex socket cap screw	M8x25	2
A90	Hex socket cap screw		1
A91	Supporter		1
A92	Washer	5/16"	2
A93	Hex cap screw	M8x20	2
A94	Screw	M5	4
A95	Stop button		1
A96	Start button		1
A97	Emergency switch		1
A98	2/4P selection switch		1
A99	Pump selection switch		1
A100	Control box panel		1
A101	Washer	5/16"	2
A102	Hex socket cap screw	M8x20	2
A103	Electric control box		1
A104	Control box button plate		1
A105	Magnetic connector		1
A106	Fuse set		1
A107	Cover plate		1
A108	Transformer		1
A109	Relay		1
A110	Plate		1
A111	Support plate		2
A112	Washer	5/16"	2
A113	Hex socket cap screw	M8x16	2
A114	Screw	M5	2
A117	Cover		2
A118	Screw		2
A119	Oil seal		1
A120	Rubber plate		1
A121	Rubber plate		1
A122	Holder plate		1
A123	Anti-dust plate		1
A124	Plate		1

Item	Description	Size	QTY
B01	Stand		1
B02	Nut	M6	4
B03	Washer	1/4"	4
B04	Support plate		1
B05	Washer	1/4"	4
B06	Hex cap screw	M6x15	4
B07	Coolant tank		1
B08	Hose		1
B09	Hose clamp		1
B10	Washer	1/4"	2
B11	Hex socket cap screw	M6x16	2
B12	Coolant pump		1
B13	Connecting bolt		1
B14	Hose clamp		1
B15	Hose		1
B16	Hose clamp		1
B17	Valve		1
B18	Wire		1
B19	Hex cap screw	M6x15	4
B20	Washer	1/4"	4
B21	Hex cap screw	M6x15	2
B22	Washer	1/4"	2
B23	Support plate		1
B24	Screw	M5x6	4
B25	Cover plate		1
B26	Collar		1

12.3 Part List B

12.4 Explosion draw B

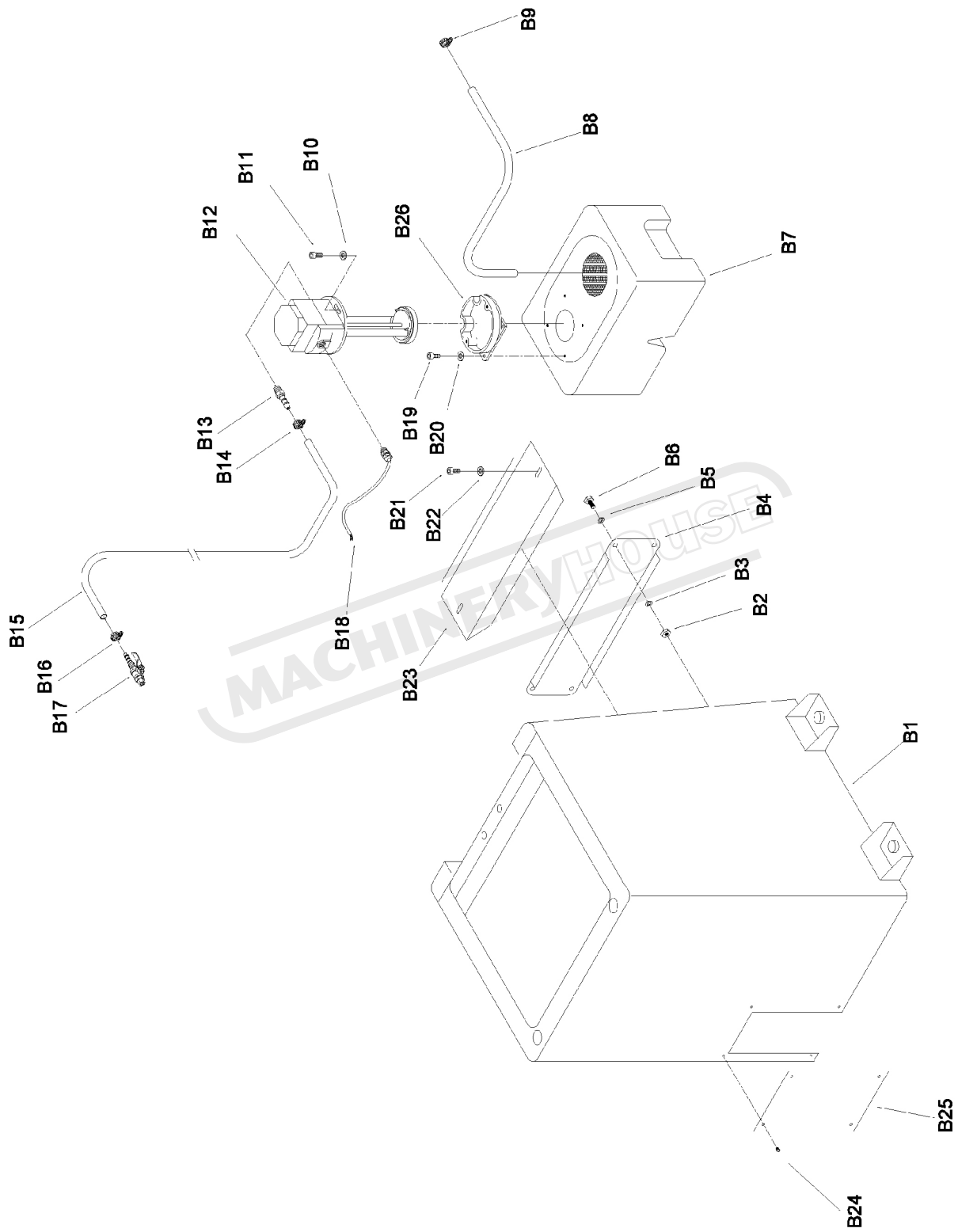

12.5 WIRING DIAGRAM AND PARTS LIST

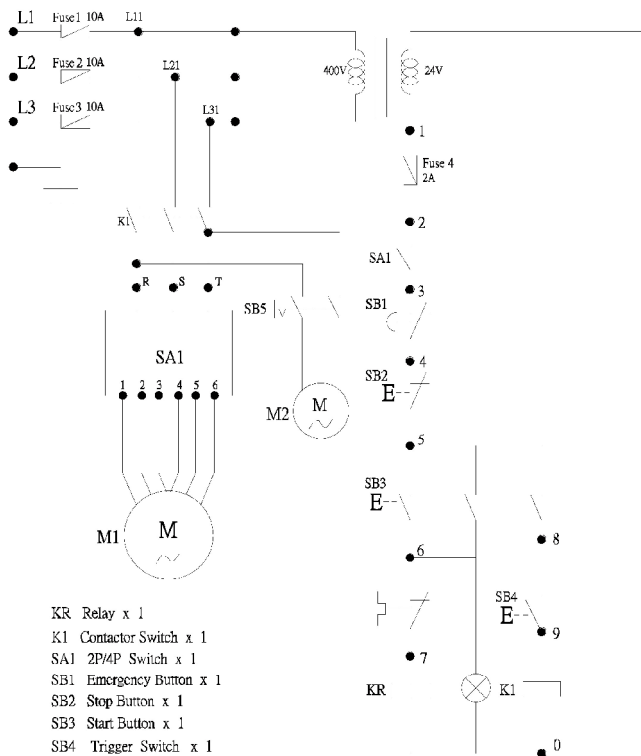

Motor connection

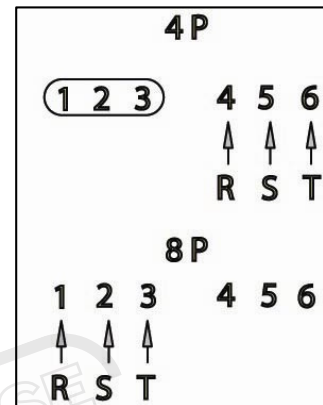
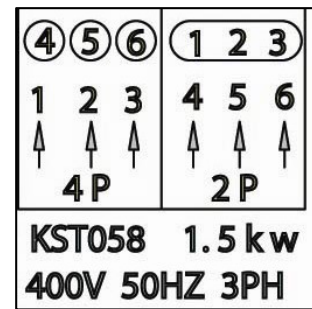

Item name	Description and function	Technical data	Quantity	Supplier	Suppliers reference	Remarks			
FU1 FU2 FU3 FU4	Fuses	30x6.2mm 250V 15A	1	JENN FENG	S15A				
	Fuses base	15A 2A 10A 4P	1						
K1	Contactor	Coil 24V It=25A 220V 2.2kw 400V 4.0kw	1				NHD	C-12D	CE ICE 158-1 BS 5424-1 VDE 0660 J13 8325
KR	Relay	250VAC 5A	1				BETA	MY-2N AC 24V	CE CSA
TC	Transformer	35VA 230/24V ,400V/24V	1	TAI CHUNG	66 , 57				
SB1	Emergency Stop	250V 6A	1	KEDU	HY57B	CE CUS			
SB2 SB3	OFF button Start button	250V 6A	1 1	MACK	ABF-22Φ1b ABLFS-22Φ1a 30V	CE CUS			
SB4	Trigger switch	15A 1/2HP 125 250VAC 0.6A 125VDC 0.3A 250VDC	1	OMRON	V-15-1A5	CE CUS			
SB5	Pump switch	250V	1	GIKOKA	OSS-22Φ	CE CUS			
SA1	Hi/Low speed select switch	440V 5kw	1	KEDU	ZH-HC-5	CE CUS			
M1	Motor	400V,230V/ (1.5kw) 2HP 3ph/2P/4P 400V,230V/ (1.5kw)2HP 3ph/4P/8P	1	KUOSHUAY	KST058 KST063				
M2	Coolant pump	400V / 3ph, 230V/1PH (0.09kw) 1/8HP	1	KUOSHUAY					

12.6 WIRING DIAGRAM AND PARTS LIST

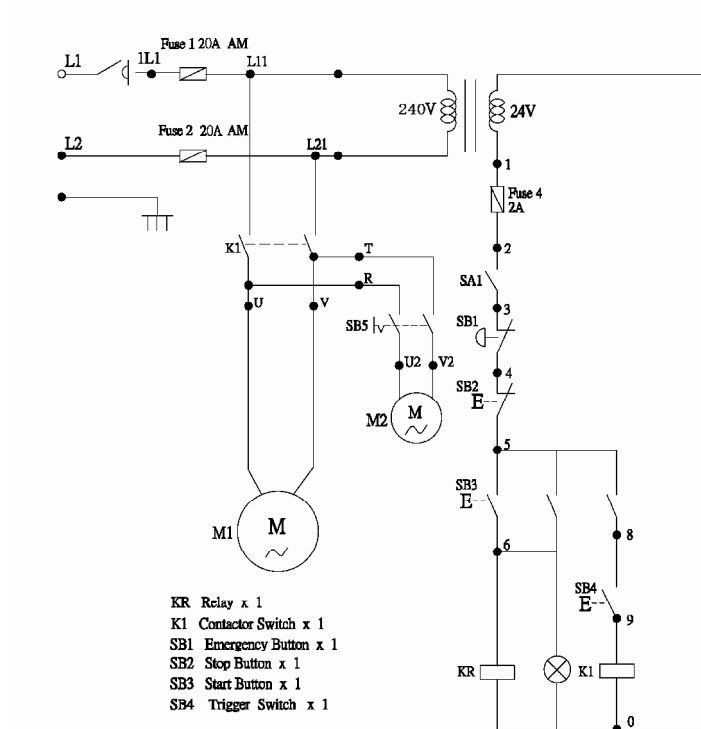

Item name	Description and function	Technical data	Quantity	Supplier	Suppliers reference	Remarks
FU1 FU2 FU3	Fuses	20A 20A 2A	1 1 1	BOSS MANN Thining ETI	FNQ-aM FNQ-aM KTK-gG VKC-10	CE CSA CUS E300304
K1	Contactor	Coil 24V It=25A 220V 2.2kw 400V 4.0kw	1	NHD	C-18D	CE ICE 158-1 BS 5424-1 VDE 0660 JI3 8325
KR	Relay	250VAC 5A	1	BETA	BMV-5-2C AC 24V	CE CUS-E115915
TC	Transformer	35VA 220 / 24V	1	TAI CHUNG	PT-66	
SB1	Emergency Stop	250V 6A	1	KEDU	HY57B	CE CUS
SB2 SB3	OFF button Start button	250V 6A 2a	1 1	MACK	ABF-22Φ1b ABLFS-22Φ1a 30V	CE CUS
SB4	Trigger switch	15A 1/2HP 125 250VAC 0.6A 125VDC 0.3A 250VDC	1	OMRON	V-15-1A5	CE CUS
SB5	Pump switch	250V	1	GIKOKA	OSS-22Φ	CE CUS
MB	Protector	30A 250V	1	YEU SHENG	OC	CE UL CUL
M1	Motor	220V / 2.5 HP 1ph / 4Pole	1	KAI SHEN		
M2	Coolant pump	220V / 1/8 HP 1ph / 4Pole	1	KAI SHEN		

13 TROUBLESHOOTION

This chapter lists the probable faults and malfunctions that could occur while the machine is being used and suggests possible remedies for solving them.

The first paragraph provides diagnosis for TOOLS and CUTS, the second for ELECTRICAL COMPONENTS.

13.1 Blade and cut diagnosis

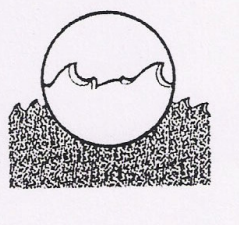
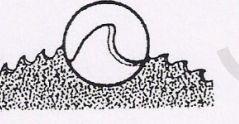
FAULT	PROBABLE CAUSE	REMEDY
<p>TOOTH BREAKAGE</p> 	<p>Too fast advance</p> <p>Wrong cutting speed</p> <p>Wrong tooth pitch</p> <p>Low quality disk</p> <p>Ineffective gripping of the part in the vise.</p> <p>Previously broken tooth left in the cut.</p> <p>Cutting resumed on a groove made previously.</p> <p>Insufficient lubricating refrigerant or wrong emulsion.</p> <p>Sticky accumulation of material on the disk.</p>	<p>Decrease advance, exerting less cutting pressure.</p> <p>Change disk speed and/or diameter.</p> <p>See chapter "Material classification and choice of disks" and the Table of cutting speeds according to disk diameter.</p> <p>Choose a suitable disk.</p> <p>See chapter "Material classification and choice of disks".</p> <p>Use a better quality disk.</p> <p>Check the gripping of the part.</p> <p>Accurately remove all the parts left in.</p> <p>Make the cut elsewhere, turning the part.</p> <p>Check the level of the liquid in the tank.</p> <p>Increase the flow of lubricating refrigerant, checking that the hole and the liquid outlet pipe are not blocked.</p> <p>Check the blend of lubricating coolant and choose a better quality disk.</p>
<p>PREMATURE DISK WEAR</p> 	<p>Wrong running in of the disk .</p> <p>Wrong cutting speed.</p> <p>Unsuitable tooth profile.</p> <p>Wrong tooth pitch.</p> <p>Low quality disk.</p> <p>Insufficient lubricating refrigerant.</p>	<p>See chapter "Material classification and choice of disks" in the paragraph on Running in the disk.</p> <p>Change disk speed and / or diameter.</p> <p>See Chapter "Material classification and choice of disks" and the Table of cutting speeds according to disk diameter.</p> <p>Choose a suitable disk. See Chapter "Material classification and choice of disks" in the paragraph on Type of disks.</p> <p>Choose a suitable disk.</p> <p>See Chapter "Material classification and choice of disks".</p> <p>Use a better quality disk.</p> <p>Check the level of the liquid in the tank.</p> <p>Increase the flow of lubricating refrigerant, checking that the hole and the liquid outlet pipe are not blocked.</p>

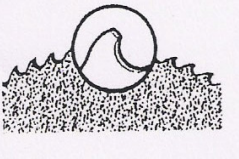
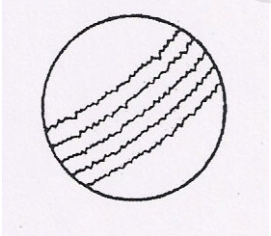
FAULT	PROBABLE CAUSE	REMEDY
<p>CHIPPED DISK</p> 	<p>Hardness, shape or flaws in the material (oxides, inclusions, lack of homogeneity, etc...) Wrong cutting speed.</p> <p>Wrong tooth pitch.</p> <p>Vibrations Disk incorrectly sharpened. Low quality disk.</p> <p>Incorrect emulsion of the lubricating Refrigerant.</p>	<p>Reduce the cutting pressure and/or the advance.</p> <p>Change disk speed and/or diameter. See Chapter "Material classification and choice of disks" and the Table of cutting speeds according to disk diameter. Choose a suitable disk. See Chapter "Material classification and choice of disks". Check gripping of the part. Replace the disk with one that is more suitable and correctly sharpened. Use a better quality disk. Check the percentage of water and oil in the emulsion.</p>
<p>DISK VIBRATION</p>	<p>Wrong tooth pitch.</p> <p>Unsuitable tooth profile.</p> <p>Ineffective gripping of the part in the vise.</p> <p>Dimensions of the solid section too large with respect to the maximum admissible cutting dimensions. Disk diameter incorrect and/or too large.</p>	<p>Choose a suitable disk. See Chapter "Material classification and choice of disks". Choose a suitable disk. See Chapter "Material classification and choice of disks" in the paragraph on Type of disks. Check the gripping of the part.</p> <p>Abide by the instructions.</p> <p>Decrease the disk diameter, adapting it to the dimensions of the part to be cut, the cutting part of the disk must not be too large for the shape of the part to be cut.</p>
<p>RIDGES ON THE CUTTING SURFACE</p> 	<p>Disk diameter incorrect and/ or too large.</p> <p>Ineffective gripping of the part in the vise. Too fast advance.</p> <p>Disk teeth are worn. Insufficient lubricating refrigerant.</p> <p>Toothing does not unload shavings well.</p>	<p>Decrease the disk diameter, adapting it to the dimensions of the part to be cut, the cutting part of the disk must not be too large for the shape of the part to be cut. Check the gripping of the part.</p> <p>Decrease advance, exerting less cutting pressure. Sharpen the tool. Check the level of the liquid in the tank. Increase the flow of lubricating refrigerant, checking that the hole and the liquid outlet pipe are not blocked. Choose a blade with a larger tooth pitch that allows better unloading of shavings and that holds more lubricating refrigerant.</p>

FAULT	PROBABLE CAUSE	REMEDY
<p>CUT OFF THE STRAIGHT</p>	<p>Too fast advance. Ineffective gripping of the part in the vise. Disk head off the straight. Disk sides differently sharpened. Disk thinner than the commercial standard. Dirt on the gripping device.</p>	<p>Decrease advance, exerting less cutting pressure. Check the gripping of the part which may be moving sideways. Adjust the head. Choose tool quality carefully in every detail as regards type and construction characteristics. Carefully clean the laying and contact surfaces.</p>
<p>BLADE STICKS IN THE CUT</p> 	<p>Too fast advance. Low cutting speed. Wrong tooth pitch. Sticky accumulation of material on the disk. Insufficient lubricating refrigerant.</p>	<p>Decrease advance, exerting less cutting pressure. Increase speed. Choose a suitable disk. See Chapter "Material classification and choice of disks". Check the blend of lubricating coolant and choose a better quality disk. Check the level of the liquid in the tank. Increase the flow of lubricating refrigerant, checking that the hole and the liquid outlet pipe are not blocked.</p>

MACHINERYHOUSE